

Koda K012

design by Drisag

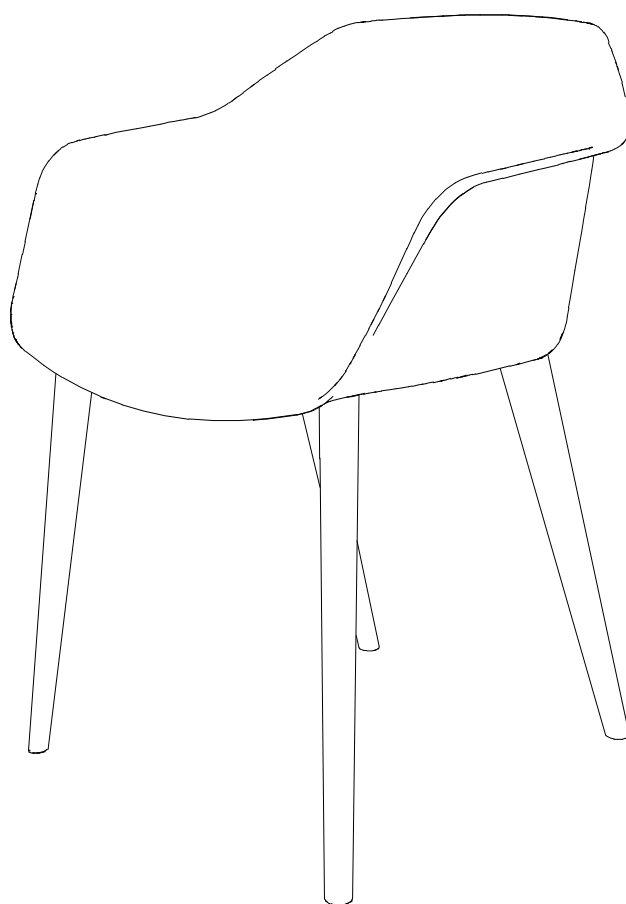

www.drisag.be — welcome@drisag.be
Experience Center & Production - Diamantstraat 8 - 2200 Herentals - Belgium — + 32 (0) 14 23 11 11
Experience Center - Krommebeekpark 22 - 8800 Roeselare - Belgium — + 32 (0) 51 67 13 09
Production & warehouse - Rietkolk 37 - 3920 Lommel - Belgium — +32 (0) 11 46 00 99

drisag

Office Inspirators
since 1970



Work pleasure by Drisag

Koda K012

design by Drisag

Product description

Koda offers a range of non-stackable project, meeting, canteen bucket chairs. Mix & match for a complete look.

Technical information

- Base: polypropylene 4-legged base (dia. 16mm) with plastic plug-in caps.
- Seat: polypropylene seat
- * Upholstery: 5mm PU foam, fabric cover with zipper
**optional*

Polypropylene colors (No upholstery)

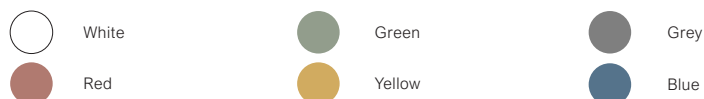

Fabrics

Available in all Drisag fabric groups.

Koda K012

design by Drisag

Dimensions

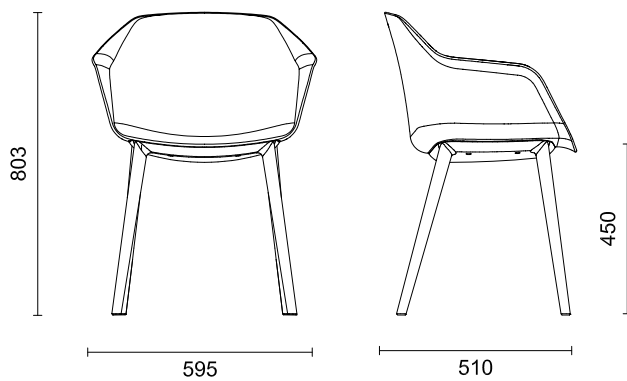

Pictures



Koda K012H

design by Drisag

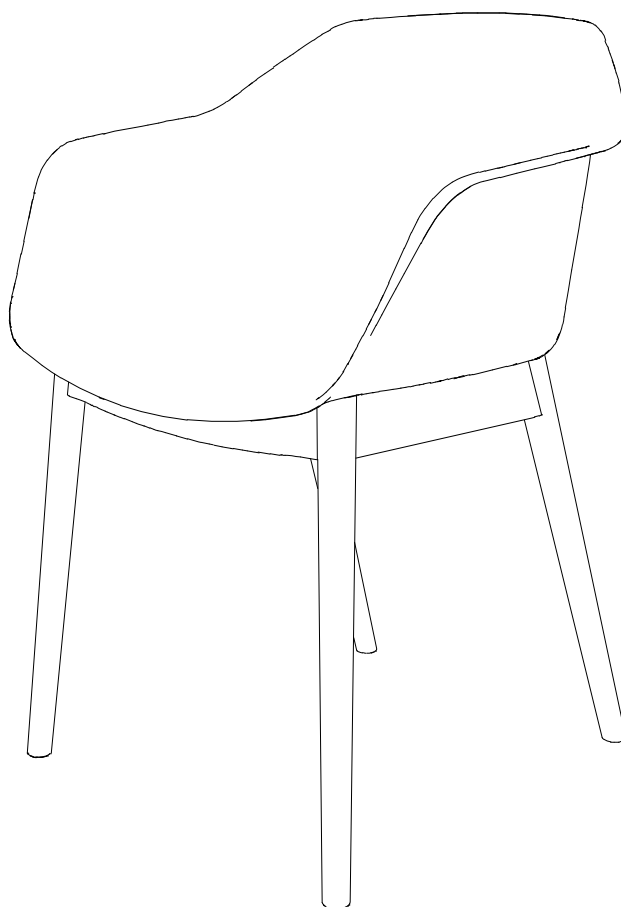



Work pleasure by Drisag

Koda K012H

design by Drisag

Product description

Koda offers a range of non-stackable project, meeting, canteen bucket chairs. Mix & match for a complete look.

Technical information

- Base: Beechwood four-legged base, fitted with felt feet.
- Seat: polypropylene bucket seat
- * Upholstery: 5mm PU foam, fabric cover with zipper
**optional*

Polypropylene colors (No upholstery)

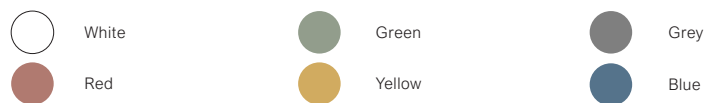

Fabrics

Available in all Drisag fabric groups.

Wooden base colors



Koda K012H

design by Drisag

Dimensions

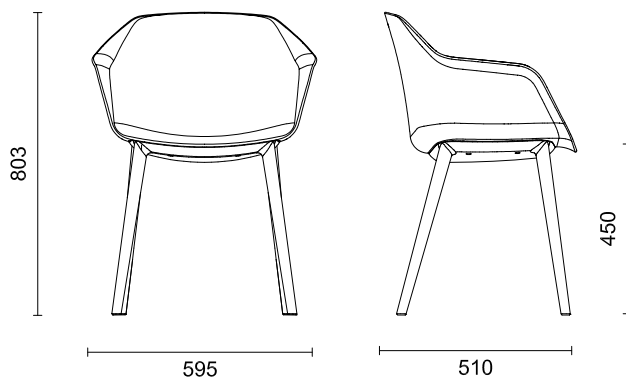

Pictures



Koda K051

design by Drisag



www.drisag.be — welcome@drisag.be
Experience Center & Production - Diamantstraat 8 - 2200 Herentals - Belgium — + 32 (0) 14 23 11 11
Experience Center - Krommebeekpark 22 - 8800 Roeselare - Belgium — + 32 (0) 51 67 13 09
Production & warehouse - Rietkolk 37 - 3920 Lommel - Belgium — +32 (0) 11 46 00 99

drisag

Office Inspirators
since 1970



Work pleasure by Drisag

Koda K051

design by Drisag

Product description

Koda offers a range of non-stackable project, meeting, canteen bucket chairs. Mix & match for a complete look.

Technical information

- Castors: 50mm, hard/soft or glides.
- Base: powdercoated
- Mechanisms: height-adjustable tilt mechanism, not lockable.
- Seat: polypropylene seat
- * Upholstery: 5mm PU foam, fabric cover with zipper
**optional*

Polypropylene colors (No upholstery)

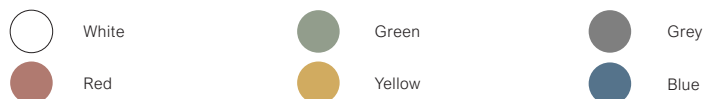

Fabrics

Available in all Drisag fabric groups.

Koda K051

design by Drisag

Dimensions

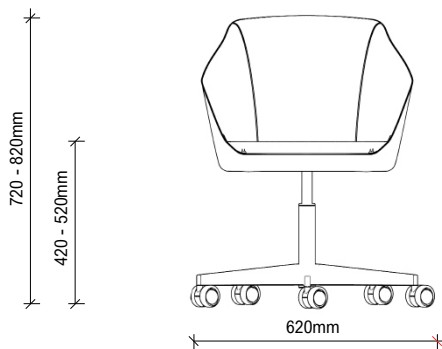

Pictures

