

Kana

design by Drisag

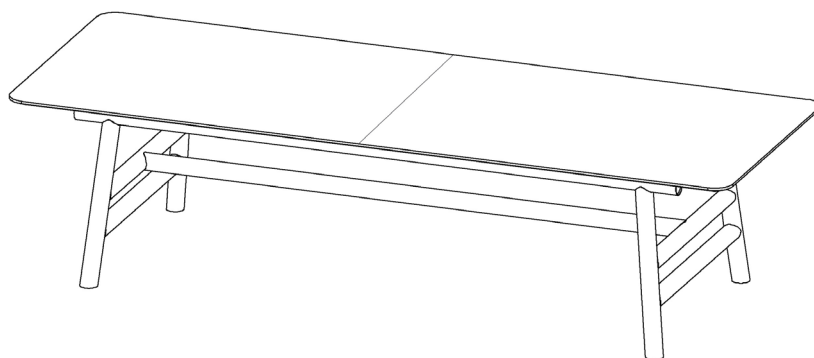
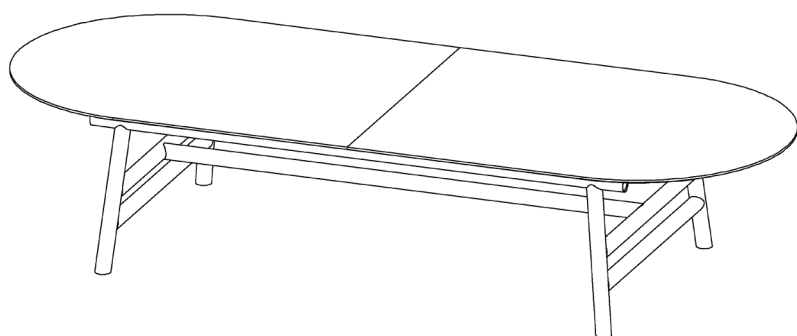

www.drisag.be — welcome@drisag.be

Experience Center & Production - Diamantstraat 8 - 2200 Herentals - Belgium — + 32 (0) 14 23 11 11

Experience Center - Krommebeekpark 22 - 8800 Roeselare - Belgium — + 32 (0) 51 67 13 09

drisag

Office Inspirators
since 1970



Work pleasure by Drisag

Kana

design by Drisag

Product description

Kana, a solid piece of craftsmanship. It includes a wide range of tables that, in addition to its robust look, has many refined details. Depending on the length, width and shape (rectangular and oval), you can place 6 to 12 people.

Technical information

- Base: powder-coated steel frame with black height adjustable plastic glides
- Tabletop:
 - a) 30mm MDF (+ HPL top) with tapered edge
 - b) 25mm melamine or nanotech with straight edge

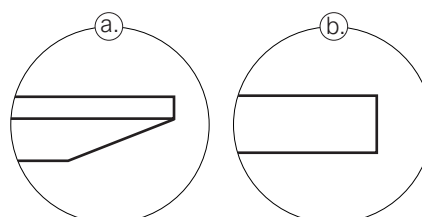

Metal colors

| | | | | | |
|---|-------------------------|---|-------------------|---|-------------------|
|  | K40 - black RAL9005 |  | K53 - grey blue |  | K50 - rusty brown |
|  | K41 - white RAL9010 |  | K57 - pale green |  | K54 - beige red |
|  | K58 - dark grey RAL7016 |  | K52 - cement grey |  | K55 - coral red |
|  | K51 - squirrel grey |  | K56 - black green | | |

Kana

design by Drisag

Tabletop colors

| | | | | | |
|---|--------------------------|---|----------------------------|---|--------------------------|
|  | W1000 - ST9 White |  | U608 - ST9 Pistachio green |  | U702 - ST9 Cashmere grey |
|  | U999 - ST9 Black |  | U636 - ST9 Fjord green |  | 0720 - Fenix black |
|  | U201 - ST9 Pebble grey |  | H3157/ST12 Vicenza oak | | |
|  | U767 - ST9 Cubanite grey |  | H1180/ST37 - Halifax oak | | |

Options

- Socket box: Accessible on both sides. Available with or without electrification unit (4 positions)
- Cable tray: 56cm. Can only be combined with socket box without infill

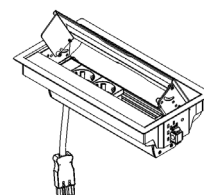
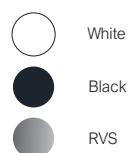

Note: if electrification must be provided, this will always be 1 box per table top. Tables consisting of 2 table tops will be provided with 2 boxes. In this case, tables are also automatically fitted with cable clips.

Dimensions

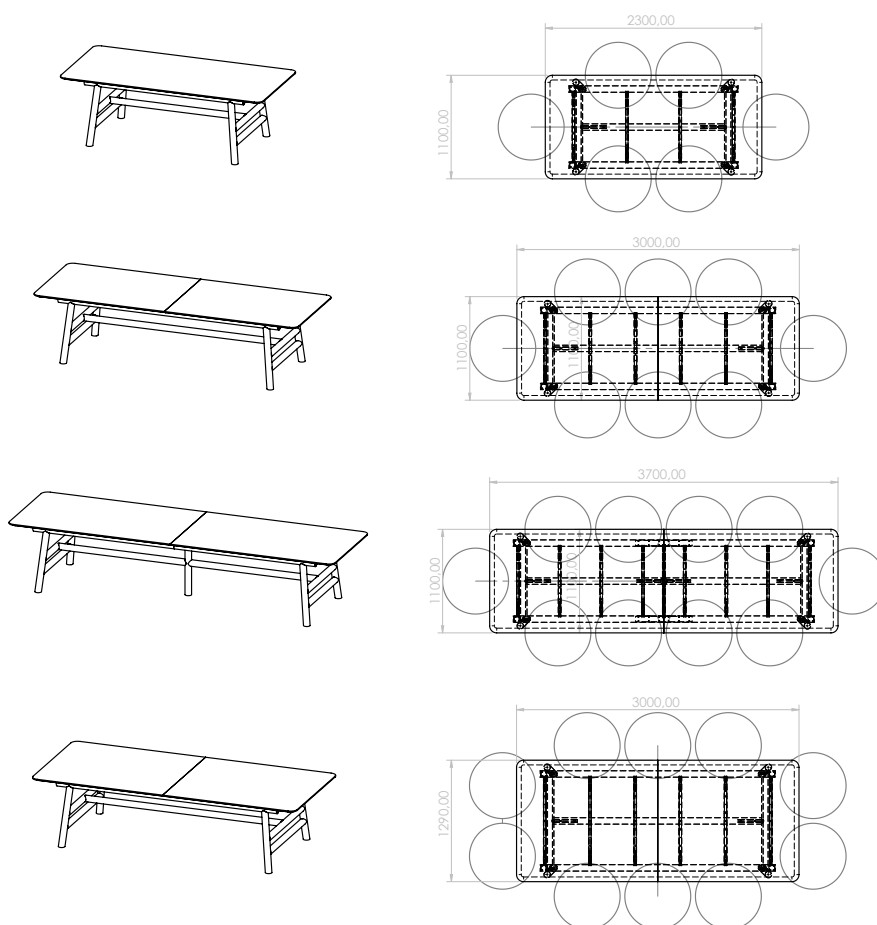

Kana

design by Drisag

Dimensions

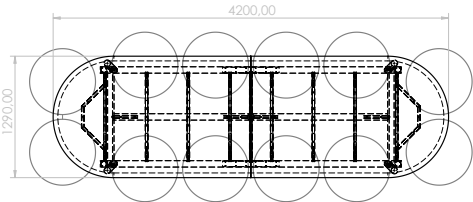
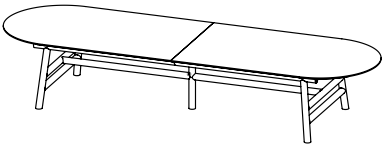
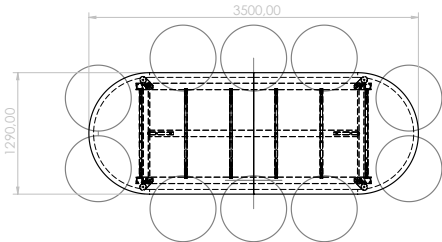
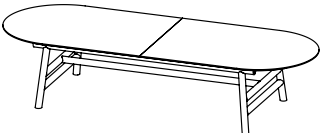
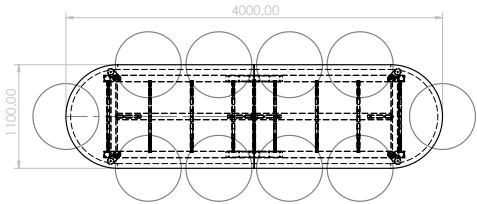
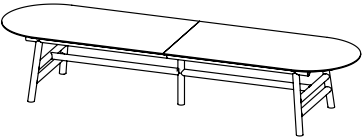
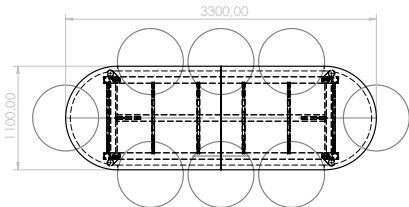
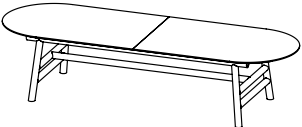
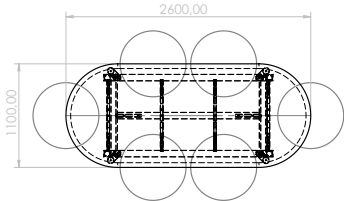
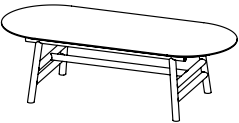
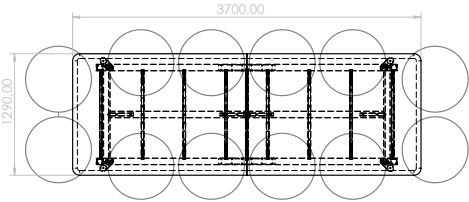
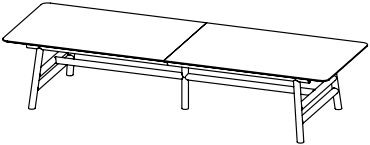

Kana

design by Drisag

Pictures

