

Prio

design by Drisag

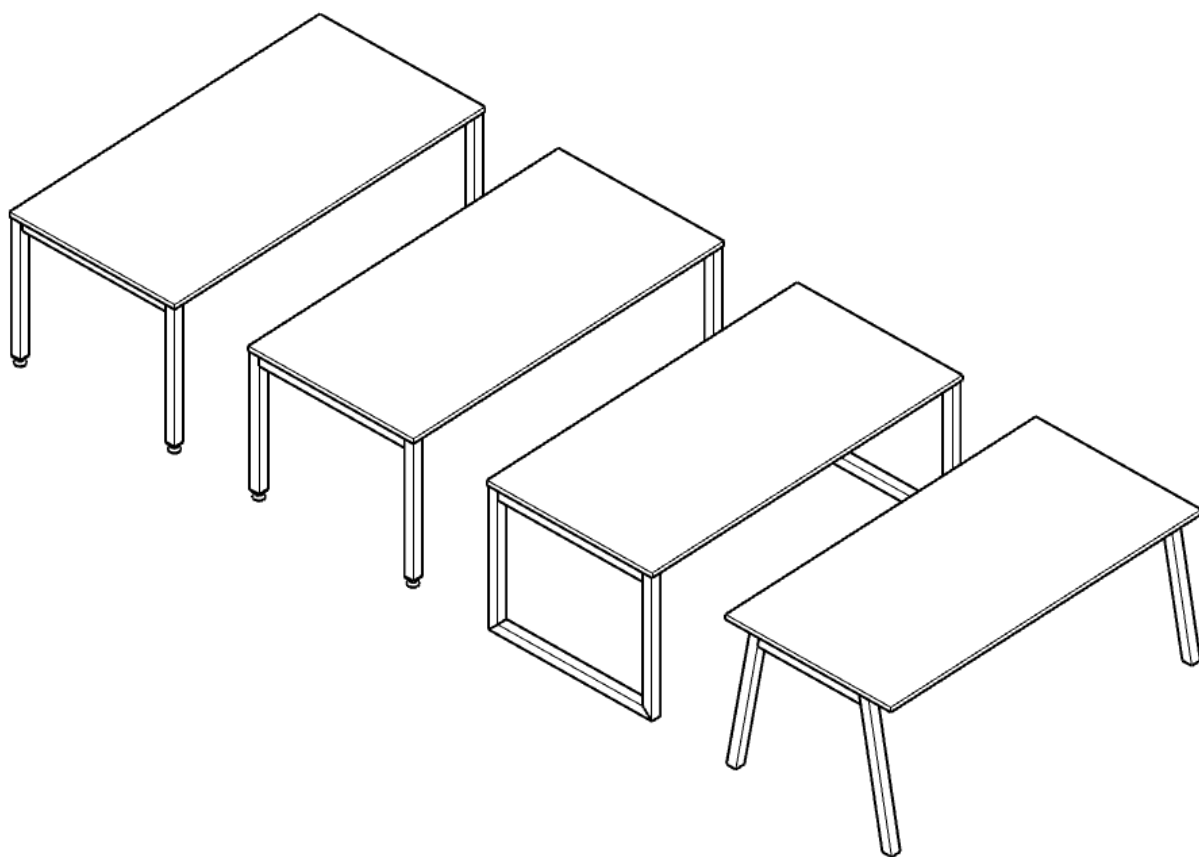



Work pleasure by Drisag

Prio

design by Drisag

Product description

Prio is a series of desks and meeting tables. Lacquered steel profiles combined with different types of legs and tabletops result in a wide range of products.

Dimensions

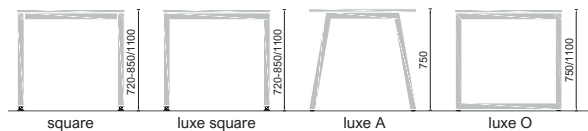

Metal colors



Tabletop colors



Options

- Prio tables can be equipped with electrification. Depending on budget and need, the following options can be chosen:
 - a. Cable inlet
 - b. Built-in unit (single)
 - c. Built-in unit, single-sided lid (with or without multiple infill)
 - d. Built-in unit, double-sided lid (with or without multiple infill)
 - e. Built-in unit, fixed (multiple infill, with or without cover)
 - f. Surface-mounted unit (multiple infill)

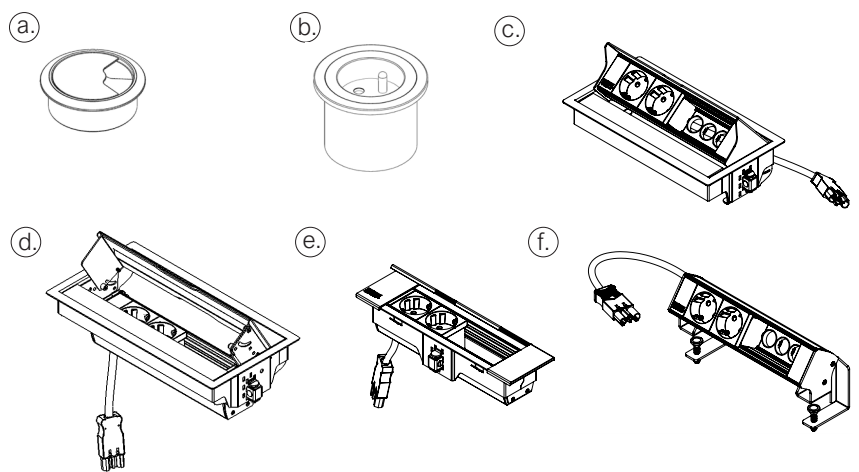

Positioning:

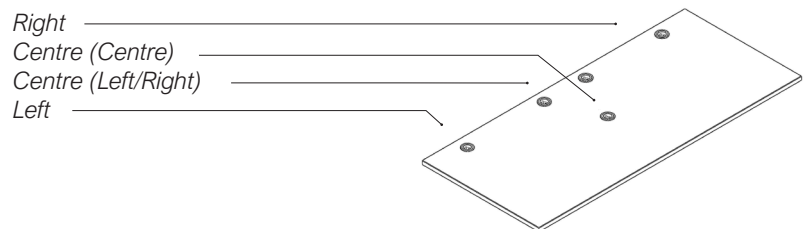

- Partition screens (info, see product sheet)
- CPU support
- Cable management:

- a. Cable-clips
- b. Cable tray
- c. Cable sleeve

Note: if electrification must be provided, tables will automatically be fitted with cable clips.

Prio
design by Drisag



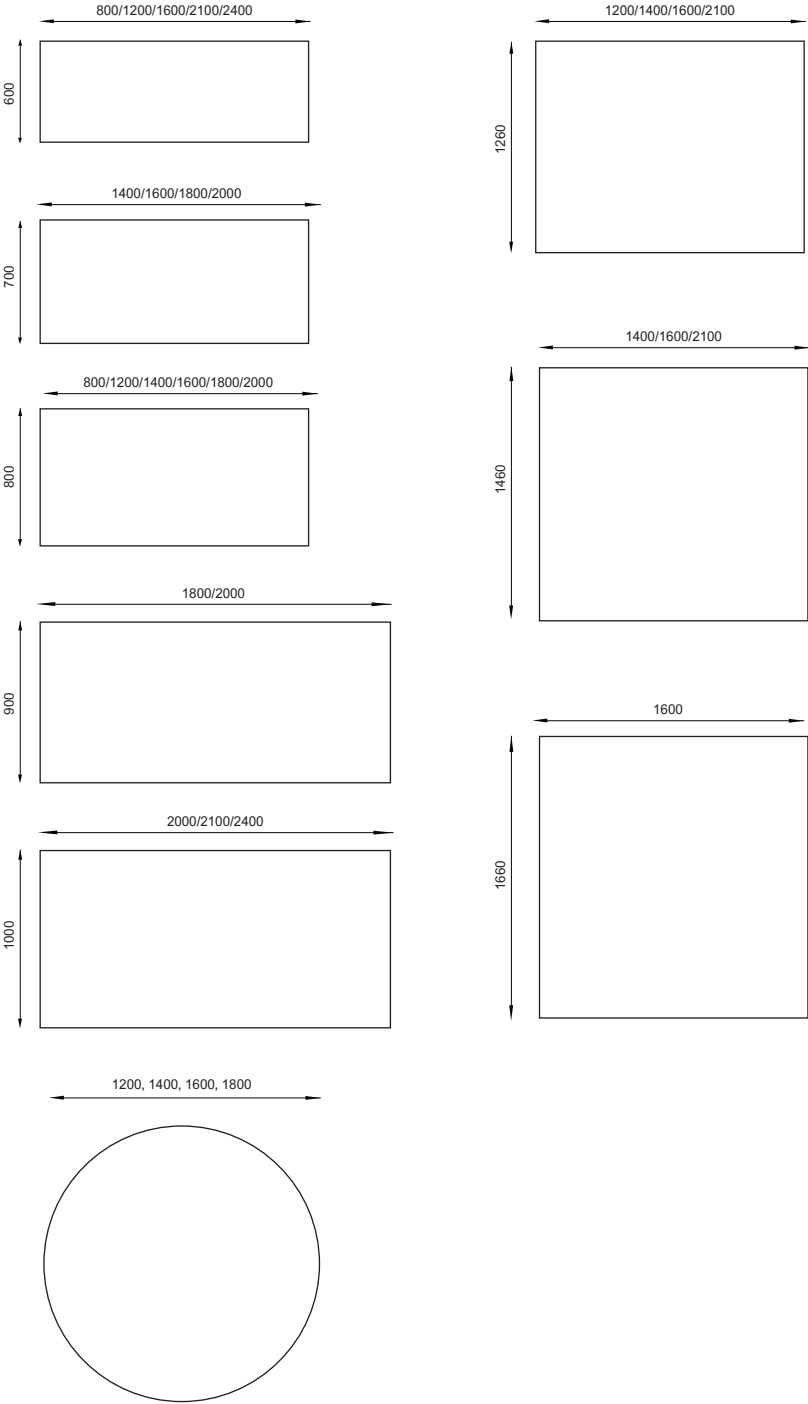













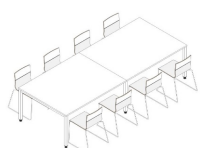

Options



Prio

design by Drisag

Models

	Square	Luxe	A	O
Complete table				
Linear arrangement with receding leg				
L setup				
Meeting bench with connection leg				
Meeting Bench with receding leg				
Standing table				
Bench 2p				
Bench 4p				

*Also Available with retracted center legs

Prio

design by Drisag

Pictures

